

Instruction Manual

Solar-powered Wildlife Camera

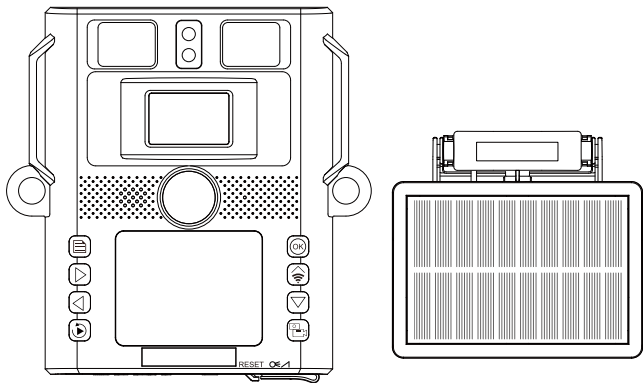

46.0

46 Megapixel

IP66

Waterproof

2.4"

IPS TFT-LCD

0.3S

Trigger time

60°

60° total
PIR angle



4K Full HD
Video function

Dear customer, congratulations on purchasing a high quality product.

You have purchased a Wildlife Camera with excellent technical features and respective accessory that is particularly easy to operate. Please study all notices carefully and diligently. Please study this information in detail observing, in particular, the safety instructions.

Precautions before use:

- Please format the TF card in the camera menu before first use.
- Before use, please remove the protective film from the infrared window, lens, and PIR lens.
- The camera is equipped with a built-in lithium battery. Please connect the TYPE-C port to charge the camera before use.
- It is recommended to use the camera with the matching solar panel. If the solar panel is not connected, please close the DC plug.
- When the product needs to enter monitoring mode, please switch the camera bottom switch to "ON" position and close the waterproof plug.
- Please ensure that there are no large obstacles within 3 meters in front of the camera to avoid abnormal exposure when the infrared light is turned on.
- When the battery power is low, the camera will pause shooting. After being charged by the solar panel, the product will automatically resume shooting.

1. Contents of box

Carefully unpack camera and check that all of the following components are contained in the box:



1

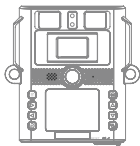

2



3

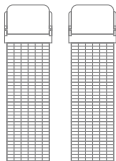

4



5

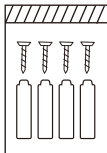

6

1. Camouflage Mask * 1

2. Wildlife Camera * 1

3. Solar panel * 1

4. Mounting Belt * 2

5. USB Cable * 1

6. Screw Packs * 1



Note:

- Remove the protective foil from the camera lens by pulling the protruding tab.
- Caution! Keep plastic foil and bags away from babies and small children, as otherwise danger of suffocation.

2. Contents

1. Contents of box	1
2. Contents	2
3. Your camera	3
3.1. Front view	3
3.2. Inside views	3
3.3. Viewscreen Indicators	4
4. Quick start guide	5
5. How to install APP	7
5.1. How to connect APP	7
5.2. Live screen of APP	10
6. Using the camera	10
6.1. Mode switch	12
6.2. Settings	12
6.3. Aligning the camera	17
6.4. Setting up the Live mode	18
6.5. Night recording	19
6.6. File format	19
7. Connecting to computer	19
8. Technical specification	21
9. Trouble shooting	22
10. System information, maintenance and disposal	26
10.1. Care	26
10.2. Storage	26
10.3. Disposal	27

3. Your camera

3.1. Front view

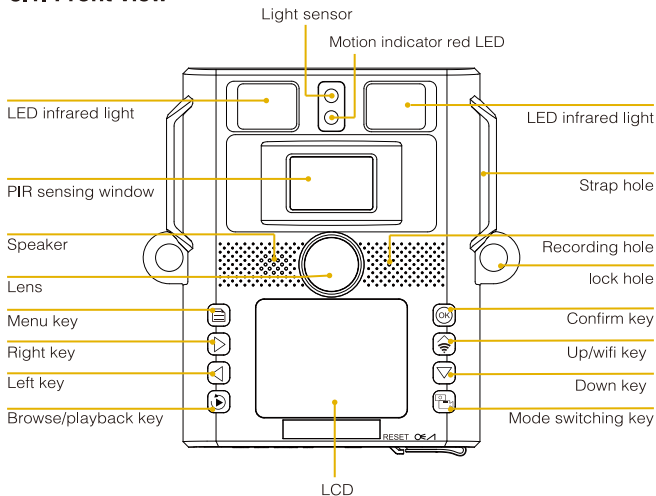

3.2. Inside views

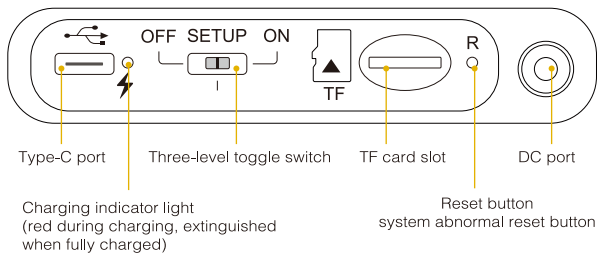

- The monitor is only switched on in the SETUP mode for changing menu settings or viewing existing photos/videos.
- The TF memory card must have been inserted into the memory card slot in order to save photos/videos.
- Using the mode switch, the three operating modes OFF, SETUP and ON can be selected.

3.3. Viewscreen Indicators

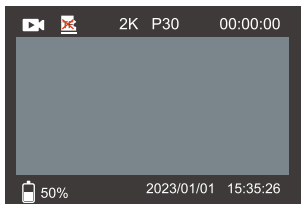
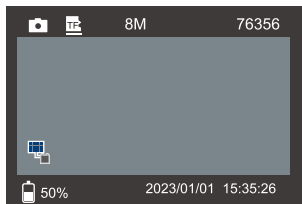

	Photo/Video Mode
	TF Card Status
8M / 2K P30	Current Image Resolution/Video Resolution
76356 / 00:00:00	Image/Video Capacity Left
	Solar/DC charging icon (When charging with an external solar panel or DC 5V adapter, the icon will be displayed. The icon will not be displayed if there is no DC/solar panel connected or if the lithium battery is fully charged.)
50%	Battery life
2023/01/01 15:35:26	Date and Time

4. Quick start guide

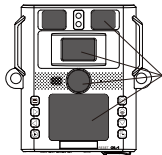

1. Remove the protective plastic covers from the camera lens, and PIR sensor.

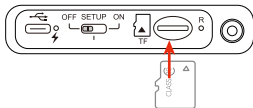

2. Install a new SD card, up to 256GB. High speed cards (class 10 or above) are recommended if you plan to record video clips. The new SD card are recommended to format with the camera before usage.



3. Download the free "WILDLIFE CAM" APP on your smartphone from the APP Store or Google Play. Or press the camera WiFi button  and scan the QR code on the screen.



4. Open the APP and follow the prompts to connect the camera.

5. At the location where you will place the camera, move the power switch to the ON position. The camera's default settings were chosen for typical usage as a scouting camera for hunters. Photo mode at 8MP resolution, with a 30 second interval between photos, and "Medium" PIR sensitivity. These settings may be easily changed to suit your individual preferences or application (for example, if you would rather capture videos, or photos at a different resolution, spaced further apart), using the app on your smartphone or menu in the camera. (Moving the power switch to the "SETUP" position)

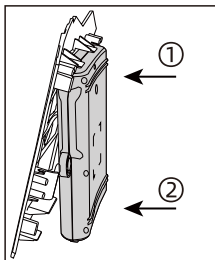
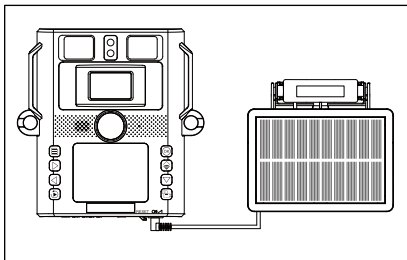
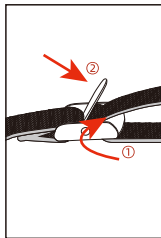
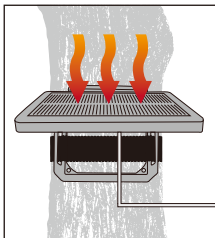
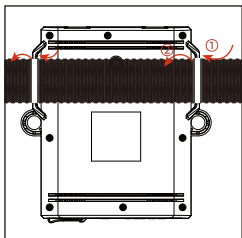

6. Mount the camera using the provided tree strap.

Now your camera is ready to use.

5. How to install APP

The wildlife camera will work with a mobile APP that is compatible with IOS and android devices. Simple download the free "WILDLIFE CAM" app from the APP store or Google Play. Or scan the QR code as below (fig. 1) to install app. The app allows you full control of all camera settings as well as the ability to view pictures and video clips uploaded by your wildlife cameras.



WILDLIFE CAM

(fig.1)

5.1. How to connect APP

1. Power on your camera and press the Mode switch to the "SETUP" or "ON" mode.
2. Upon opening the "WILDLIFE CAM" app on your mobile device and you would be at the Main page. On the Main page (fig.2), click the camera icon "+" on the lower right corner of the screen to start the connection



(fig.2)

The following figure shows the interface changes during the connection process. (we take the ISO system as example)

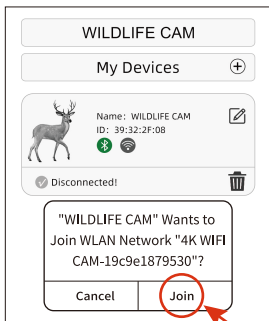
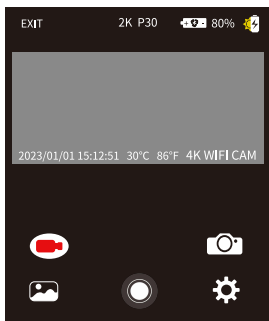
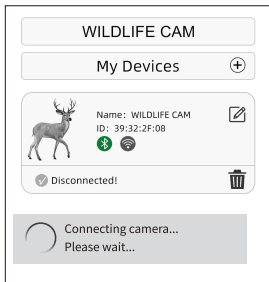

As shown in the picture above, when the wifi icon turns green and also the wildlife camera display "wifi connected". That means the APP has successfully connected with your mobile phone. And then the mobile phone interface would jump to the real-time preview interface as shown in below.





Note:

- Please make sure the wifi and Bluetooth function are opened in your mobile phone device.
- During the app connection, it would pop-up some window for questions, please choice the "Ok" or other agreement option. The ISO and Android 10 or above system would be a little bit difference interface. Just follow the specific prompts in your phone.

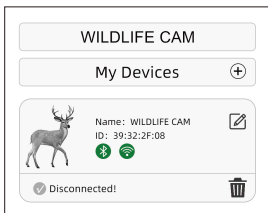
After the APP is successfully connected to the camera device for the first time, the APP will automatically save the connected camera device in the "My Devices" list. When the user opens and uses the APP again, it will directly jump to the "My Devices" list. Click the selected camera device in the list to automatically connect to the APP, as shown below.



	Search for the camera device
	Modify the camera name in the APP display. This is only easy for users to identify the camera if they use some cameras in the APP. Please note that the modification only for the app interface not real in the camera. The camera name display in the camera still not changed.
	Delete the camera saving record in the camera list

5.2. Live screen of APP

The live screen of APP shows the current live image from the wildlife camera and also offers the following options:

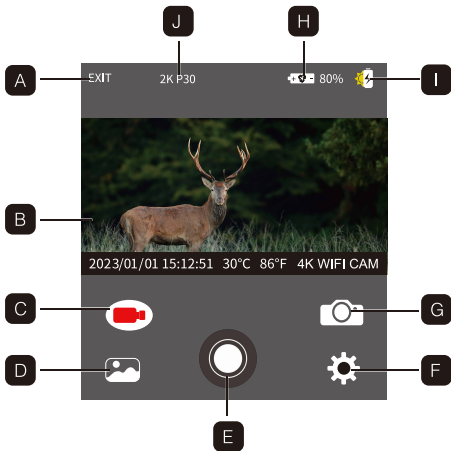









- A. Exit the APP
- B. Live image
- C. Video mode
- D. Image or video preview
- E. Release button
- F. Settings
- G. Photo mode
- H. Battery life
- I. Solar charging indication
- J. Current picture or video resolution

6. Using the camera

Prior to setting up the camera for surveillance, it must be set up for the respective purpose. For this purpose, there is a setup mode available. In addition to changing settings, photos and videos can be taken and existing photos can be viewed in this mode.

Operation Buttons

Button	Function
	Switch the camera mode between OFF/SETUP/ON.
	In video/photo mode, short press to enter into MENU settings. In MENU setting mode, short press to exit the current setting or exit MENU setting mode. In playback mode, short press to enter into deleting or protecting video or photo files.
	In video/photo mode, short press to show the QR code. In MENU setting mode, short press to move up the menu or increase the value by 1. In playback mode, view taken pictures/videos forwards.
	In MENU setting mode, short press to move down menu or decrease the value by 1. In playback mode, view taken pictures/videos backwards.
	In MENU setting mode, short press to move left to MENU setting. In video playback mode, short press to rewind the video playback.
	In MENU setting mode, short press to move right to MENU setting. In video playback mode, short press to accelerate video playback.
	In video/photo mode, short press to take a picture/video or stop video shooting. In MENU setting mode, short press to confirm selection and changes. In video playback mode, short press to play or pause the video playback.
	In video/photo mode, short press to switch the working mode.
	In video/photo mode, short press to enter into playback mode. In playback mode, short press to exit playback mode.

6.1. Mode switch

Open the camera as described in section 6.1. The Mode switch is located at the bottom edge on the left inside. 3 operating modes can be selected:

OFF :The camera is completely switched off in the OFF mode.

SETUP: Select SETUP mode to adjust settings and make or playback photos and videos.

ON: The camera is activated to take photos automatically (Live mode).

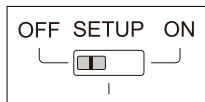

6.2. Settings

Prior to using the Wildlife Camera, change the settings as required. Slide the mode switch of the Camera to the SETUP position to start the setup mode. In the Photo or Video mode press the MENU button to call up the menu. All menu options of the Camera and possible setting values for the recording mode are listed below. The standard setting is always highlighted in bold.

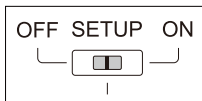

- **Mode : Photo**, Video, Photo + Video

Select whether photos or videos should be taken when motion is detected. When in the "Photo + Video" mode, the camera first takes a set number of photos prior to recording a video.

- **PIR Interval: Defaulted 30seconds**, optional from 5seconds ~60minutes
Select the setup period for the camera to wait before it reacts to the successive triggering of the main sensor after an animal has first been detected. The camera does not record any images or videos during the selected interval. This prevents the memory card from being filled with unnecessary shots.



Note:

- The interval time is short, the camera shooting frequency would be high, and there would be high consumption of batteries. It would effect the usage days of the batteries. It is just on the opposite ,the interval time is long, would be a lower consumption of batteries to guarantee a long time usage.
- **PIR Sensitivity:** High/ **Medium**/ Low
- **Time lapse: Off/On**
When “on” has been selected, the camera would automatically take photos/ videos in the selected time interval, irrespective of whether or not the PIR sensor has detected a motion or not. This is useful for observing cold blooded animals e.g. snakes or plants opening up, etc.
As soon as the "On" setting has been confirmed by pressing the OK button, you can enter the interval time after which photos/ videos are to be taken.



Note:

- In this mode, the PIR function would stop working, and the camera would take photos/ videos in the setting interval time.
- **Loop Recording: On/Off**
If choose On, the camera will delete the earliest pictures or videos after the TF card is full.
- **IR LED: Auto/ Medium/ / Low/ Off**
Set the infrared LEDs brightness.

- **Low Battery at Night: No IR Led/ No Shutting**
 - **No IR Led:** The camera takes photos and videos without opening IR LEDs at night when battery is quite low.
 - **No Shutting:** The camera doesn't take photos and video at night when the battery is quite low.
- **Monitoring Period: Off/On**
 Set timer to "On" if camera should only be active within a certain time. Once "On" has been confirmed with the OK button, the start and end time can be set.

 If the start time is, for instance set to 18:35 hrs and the end time to 8:25 hrs, the camera will be operational from 6:35 pm of the current day until 8:25 am of the following day. The camera will not be triggered and will not take any photos or videos outside of this period.
- **Frequency: 50Hz/60Hz**



- Image size : 46M:9040 x 5072; 44M:8832 x 4960; 40M:8416 x 4736; 36M:8000 x 4496; 30M:7392 x 4160; 24M:6544 x 3680; 20M:5888 x 3312; 16M:5376 x 3024; 12M:4608 x 2592; 8M: 3840 x 2160; 4M: 2560 x 1440; 2M: 1920 x 1088

 Select the desired resolution for photos. We recommend the resolution **8M**.

 A higher resolution produces a somewhat better photo quality but results in larger files requiring more space on the memory card. 46M, 44M, 40M, 36M, 30M, 24M, 20M, 16M, 12M resolutions are generated by interpolation which can also affect quality.
- **Picture NO:1P, 2P, 3P, 4P, 5P, 6P, 7P, 8P, 9P, 10P.**
 Select the number of photos to be taken in succession when the camera is triggered in the Photo mode. Please also observe the parameter Interval!
- **Shutter speed: 1/15, 1/20, 1/30**



- **Resolution:** 4K(3840 x 2160@30fps); **2K(2560 x 1440@30fps)**;
1296P(2304 x 1296 30fps); 1080P(1920 x 1080 30fps);
720P(1280 x 720 30fps); 480P(848 x 480 30fps); 360P(640 x 368 30fps)

Select the required video resolution.

A higher resolution produces higher quality videos but results in larger files requiring more space on the memory card.

- **Video Length: Defaulted 10seconds**, optional 5seconds~180seconds
Specify the duration of a video recording when the camera is triggered automatically. The recording period for videos is not limited in the SETUP mode.
- **Record Audio: Off/On**



- **Language:** Select the desired menu language
The following languages are available: **English**, German, French, Spanish, Chinese, etc.
- **Default setting(Reset to factory): Cancel/OK**
Press "OK" to reset the camera settings to the default values and confirm the selection by pressing the **OK** button.
- **Format: Cancel/OK**
All files are deleted by formatting the memory card. Press **OK** button and confirm formatting by selecting "OK".
We recommend formatting the memory card if it has already been used in other devices or if it is a new card.
Caution: Ensure that files still required have been backed up prior to formatting!

- **Date / Time:** Set date and time
- **Time Format:** 12hour/ **24hour**
- **Date Stamp: On/Off**
Select "ON" to print the date, time, temperature, battery percentage and moon phase on each photo or video. Otherwise select "Off".
- **Beep Sound: On/Off**
- **Camera name: 4K WIFI CAM**
You can use a combination of 10 digits and 26 letters to document the location on the photos and videos. When using several cameras this makes it easier to identify the location when viewing photos and videos.
- **Password Setting: Off/On**
After selecting "On" enter a four digit password to protect your camera against unauthorised access.
This password must be entered each time the camera is switched on in the SETUP mode before the camera can be used.



Note:

- If you forgot your password, please unlock the camera with password "OPEN".
- **Password For APP: Off/On**
- **Auto WIFI Off:** 1 Minute/ **2 Minute**/ 3 Minute
- **Auto Power Off: 3 min**/5 min/10 min/Off
If there is no operation more than the selected time, then the camera will turn off automatically in SETUP mode.
- **Backlight: 1Minute**, 3Minutes, 5Minutes, Off
The LCD monitor would automatically turn off after the setting time.
- **Version:** You can check the software version.
- **Firmware Update**

- In replay mode the option Delete and Protect are available in the menu.
- **Delete:** Select the “Delete” option to remove individual or all photos and videos from the memory card thus making storage room for new photos and videos.
- **Delete Current:** Using this option you can delete individual photos and videos. After selection the option by pressing the OK button, the photo and video to be deleted is shown. Confirm deletion by selecting “Yes” and confirming the selection by pressing the OK button. To end the deletion process, select “No” and confirm by pressing OK.
- **Delete All:** Select option “All” to delete all photos and videos on your memory card. To confirm deletion of all your photos and videos, select “Yes” and press the OK button. Select “No” to interrupt the deletion operation.
- **Protect:** Lock Current/ Unlock Current/ Lock All/ Unlock All.

6.3. Aligning the camera

The Test mode is advantageous for determining the best possible detection angle and range of the movement sensor. For this purpose attach the camera at approx. 1-2 m height to a tree and align the camera with a desired direction. Move slowly from one side of the observed area to the other. Move parallel to the camera. Try out different angles and distances.

- The red LED on the front of the camera indicates that you were detected by a central sensor zone.

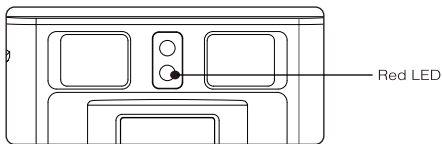

In this way you can determine the best position for aligning the camera. The LED only lights up in the SETUP mode as soon as one of the sensors has detected movement. The LEDs do not light up when in Live mode.

In order to prevent incorrect signals and unnecessary photos, we recommend not using the camera at sunny points and check that no branches are in the active area of the sensor. Optimum alignment is in North or South direction. The detection range of the sensors is approx 60°.

Also check that the camera is set to the correct height in line with the point to be observed. Where necessary, point the camera down for optimum alignment.



Note:

- Wildlife Camera corresponds to protection class IP 66. The camera is protected against dust and spray water and can thus be used in any weather condition.

6.4. Setting up the Live mode

The standard application of the Wildlife Camera is the Live mode. When in this mode, photos are either triggered by movement sensors or at intervals according to the respective setting.

To set up the Live mode, switch mode switch to ON position.

The red status LED flashes for approx. 5 seconds after which the camera operates automatically and enters the Standby mode.

As soon as wild animals or other objects directly enter the detection area of the central sensor zone, the camera starts to record photos and videos.

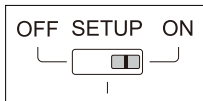

6.5. Night recording

During night recording the infrared LEDs (IR LEDs) at the front of the Wildlife Camera provide the light required for taking photos. Wildlife Camera uses IR LEDs with a long wavelength, to keep red light to a minimum. The provided number of IR LEDs generates a high deflection angle thus allowing night recording at a distance of 3 m to 20 m, without overexposing the object. Reflecting objects can, however, also cause overexposure within this range (e.g. road signs).

Please note that night recording using IR LEDs produces black and white images.

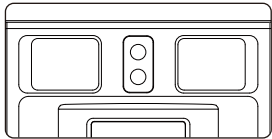

6.6. File format

The Wildlife Camera stores photos and videos on the memory card in the folder `\DCIM\MOVIE&PHOTO`.

Photos are given a file name with extension "JPG" (Example: "IM_00001.JPG"), videos, are given the extension ".MP4" (Example: "VD_00002.MP4").

When in SETUP and OFF mode use the enclosed USB cable to transfer files onto the computer. Alternatively you can insert the memory card in a card reader on the computer.

The video file can be played with most standard programs, such as Windows Media Player, QuickTime etc.

7. Connecting to computer

The Wildlife Camera can be connected to a computer using the supplied USB cables to view existing photos/videos.

System requirements

Windows	Macintosh
<ul style="list-style-type: none">■ Pentium III or higher■ Windows XP/Vista/7/8■ 512 MB RAM■ 1GB available hard disk space■ Screen resolution 1.024 x 768 or higher■ Available USB connection	<ul style="list-style-type: none">■ PowerPC G3/G4/G5■ OS 10.3.9 or newer system■ 512 MB RAM■ 1GB available hard disk space■ Screen resolution 1.024 x 768 or higher■ Available USB connection

1. Connect the camera to your computer using the USB cable in SETUP/ON mode.
2. The camera switches on automatically in the USB mode, irrespective of the selection on the mode switch.
3. The camera installs itself on the computer as an additional drive under the name "Removable storage device".
4. Double click on the device to detect the folder "DCIM".
5. The photos and videos are located in the sub folders of the "DCIM" folder.
6. You can copy or move photo and video files on the computer. Alternatively you can insert the memory card in a card reader on the computer.

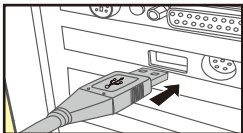

Note:

- Mac computers show an "Unknown" drive on the desktop. When clicking on this drive, the program "iPhoto" is automatically started.

8. Technical specification

Lens	f=4.15mm F/NO=1.6 FOV=93 °
Picture Resolution	46M:9040 x 5072; 44M:8832 x 4960; 40M:8416 x 4736; 36M:8000 x 4496; 30M:7392 x 4160; 24M:6544 x 3680; 20M:5888 x 3312; 16M:5376 x 3024;12M:4608 x 2592; 8M: 3840 x 2160; 4M: 2560 x 1440; 2M: 1920 x 1088
Video resolution	4K(3840 x 2160@30fps); 2K(2560 x 1440@30fps); 1296P(2304 x 1296 30fps); 1080P(1920 x 1080 30fps); 720P(1280 x 720 30fps); 480P(848 x 480 30fps); 368P(640 x 368 30fps)
Video Format	JPEG/MPEG-4(H.264)
Display Screen	2.4" color TFT LCD
Trigger distance	65ft/20meters
Trigger time	Appr. 0.3 second
Detection angle sensor	60°
IR flash range	65ft/20meters
Functions	Multishot 1 to 10 images, interval 5 sec. to 60 min., video length 5 sec.to 3 min, interval recording, timer, password protection, image info stamp, low battery alarm
Memory	TF card up to 256 GB
WiFi	2.4-2.5GHz 802.11 b/g/n (High-speed up to 150 Mbps)
WiFi functions	Take photos and videos, real-time preview, download/ delete the taken photo and video files, change MENU settings, check battery and memory capacity in the APP.
Power	3.7V/5,000mAH Lithium battery with solar panel
Solar Panel power	1.2 Watt
Charging time via USB	About 7hours in power off mode; About 24hours in SETUP/ON mode

Charging time via Solar Panel	About 4-10days at optimal sunshine
Power Supply	Solar Panel included or external 5V/1A adaptor
Bluetooth 5,0 frequency	2.4GHz ISM frequency
Average Battery Life	Uninterruptible power supply outdoor, Up to 12 months without solar panel charging indoor
Connectors	USB type-c
IP class	IP66 Waterproof
Operating Temperature	-20 - 60°C
Storage temperature	-30 - 70°C
Operating Humidity	5% - 90%
Weight	approx. 290g(without mask and solar panel)



Note: Design and technical specification are subject to change.

9. Trouble shooting

Camera won't POWER UP?

- Please ensure that the battery is charged.
- Press the 'R' reset button on the bottom of the camera to restart the camera.

Camera stops taking images or won't take images?

- Please make sure that the SD card is not full. If the card is full, the camera will stop taking images.
- Make sure that you are using a good quality SD card in your camera. We recommend SanDisk SD Cards up to 32GB. If the SD card has its write protect switch in the lock position, the camera will not take images.
- If you have used an SD card in another device before inserting it in our camera, you might want to try formatting the card by using our camera. In some cases, other devices may change the formatting of the SD card so that it will not work properly with our camera.

- Press the “R” reset button at the bottom of the camera to restart the camera system in the condition of SD card and battery are installed correctly.

Camera takes continuous images of no subject?

A camera has what is known as a “false trigger” if the PIR sensor thinks that there is motion and heat in front of the camera lens when there is no subject in the image. These “False Triggers” are the result of placing the camera in an environment where there is motion associated with tree branches creating motion in front of the camera or an area where there is high heat in the foreground and any motion from wind could set off the camera. Setting a camera up over water is also a potential cause for this issue. To remedy this situation:

- Try moving the camera to an area that does not have any of these issues or try changing the sensor level on the menu settings.
- If the camera continues to take images when there is no subject in them, try placing the camera in an inside environment and aiming at a location where there is no motion.
- If the camera continues to show issues, then there is probably an electronic component issue. If this is the case, please contact our customer service to send the camera back for repair.

Battery life is shorter than expected?

- The setting you select for “PIR interval” and “Video Length” in the Setup Menu will have a significant impact on battery life. Shorter interval time and long video length setting are all lead to short battery life. We suggest to go with the defaulted setting of Interval time 30SEC or above, and the video length within 10sec.
- Battery life will vary with operating temperature and the number of images taken over time. Typically, the Camera will be able to capture several hundred images before the batteries die.
- Make sure that you are using a good quality name brand SD card in your camera. We recommend SanDisk brand SD Cards up to 32GB. Our experience indicates that poor quality SD cards can sometimes reduce your camera battery life.

Still photo and/or video quality problems?

1. Night photos or videos appear too dark.

- Check the battery indicator icon to see if battery power is full. The flash will stop operating near the end of the battery life.
- You will get the best results when the subject is within the ideal flash range, no farther than 15 meters from the camera. Subjects may appear too dark at greater distances.
- Make sure “LED” in the PHOTO menu is set to “Auto” or “High” to ensure maximum output.

2. Daytime photos or videos appear too dark.

- Make sure that the camera is not aimed directly at the sun or other light sources during the day, as this may cause the camera’s auto exposure to produce darker results.

3. Night photos or videos appear too bright.

- If the subject is close to the camera (less than 10ft/3m), change the LED Control parameter in the Setup Menu to “AUTO” or “LOW”.

4. Daytime photos or videos appear too bright.

- Make sure that the camera is not aimed near an extremely dark area during the day. The auto exposure may “overcompensate” by lightening the image too much.

5. Short video clips—not recording to the length set.

- Check to make sure that the SD card is not full.
- Make sure that the camera has good batteries in it. Near the end of the battery life, the camera may choose to record shorter video clips to conserve power.

Photos do not capture subject?

- Check the “PIR SENSITIVITY” parameter setting (SETUP menu). For warm temperature conditions, set this to “HIGH” and for cold weather use, set the PIR sensitivity to “LOW”. For variable weather, use “MEDIUM”.
- Try to set your camera up in an area where there is not a heat source in the camera's line of sight.
- In some cases, setting the camera near water will make the camera take images with no subject in them. Try aiming the camera over ground.
- Try to avoid setting the camera up on small trees that are prone to being moved by strong winds.
- Remove any limbs which are right in front of the camera lens.

PIR sensor led flashes/doesn't flash?

- When the camera is in the “Setup” mode, a special LED on the front of the camera will flash when it senses motion. This is for setup purposes only and will help the user aim the camera.
- During use, the LED will not visibly flash when the camera takes an image. The LED array uses infrared light to help keep the camera hidden from game.

Display screen comes on but then powers off?

- The display automatically turns off if no control keys are pressed for 30 seconds, to conserve battery power.

Solar panel won't charge?

- Please clean the surface of the solar panel to ensure it won't covered by dust.
- The solar panel charging temperature is between 0 degree to 50 degree, the sunlight intensity, irradiation time and ambient temperature all affect the charging efficiency. Please ensure the camera is on the condition of sunshine.

Unable to connect the camera's Wi-Fi with the app?

- Check if the app's connection password is turned on and if the password is correct. Try force quitting the app and reopening it.

Forgot the app's connection password?

- Please restore the default settings. The default Wi-Fi password is '0000'.

10. System information, maintenance and disposal

- Microsoft® and Windows® are trademarks of Microsoft Corporation registered in the US.
- Pentium® is a registered trademark of Intel Corporation. Macintosh is a trademark of Apple Computer Inc.
- SD™ is a trademark.

10.1. Care

Do not use any corrosive cleaners, such as methylated spirits, thinners, etc. to clean the camera housing and supplied accessory. When required, the clean system components with a soft dry cloth.

10.2. Storage

Always remove the battery from the housing if the camera is not being used for some time and store the battery separately. On a day to day basis and over longer periods the batteries can be kept at a dry location out of the reach of children.

10.3. Disposal

For disposal, separate packaging into different types and dispose of in line with environmental regulations in supplied collection containers. Batteries and storage batteries may not be disposed of in domestic waste. Consumers are obliged by law to return used batteries to communal collection points or dealers selling batteries. Storage batteries and batteries do therefore contain the adjacent symbol.

Correct disposal of product:

The adjacent symbol indicates that electrical and electronic equipment may not be disposed of in domestic waste in the EU. Please use the returns and collection points of your local council or contact your dealer you purchased the product from. This prevents potentially harmful effects on the environment and health as a result of incorrect disposal. For further information contact the respective department of your local council.

